



Water Circulation Pumps & Circulators

Hot-Link® Domestic Hot Water Recirculation System

The Taco Hot-Link® System (HLS-1) for domestic hot water recirculation reduces the time it takes for hot water comfort to reach showers and faucets. The Hot-Link System can save an average family up to 12,000 gallons of water per year and it's easy to retrofit to an existing plumbing system.



Features

Hot-Link® delivers instant hot water using existing plumbing system!

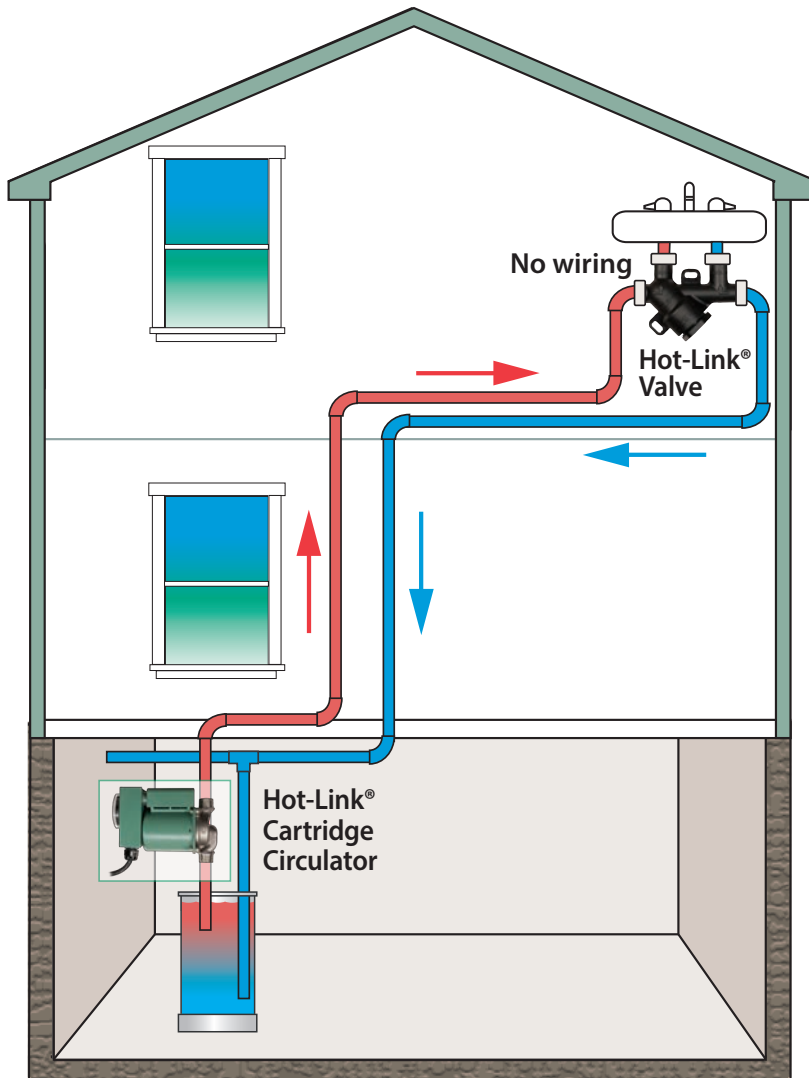

Features:

- Exclusive clean in place undersink valve design
 - Extends valve life
 - Reduces customer calls to replace "plugged" valves
- Creates a domestic hot water recirculation system without dedicated return loop piping
- Easy to retrofit to existing plumbing system
- Conserves water by greatly reducing the time it takes to get hot water
- Analog pump timer allows you to set the system to work during peak hours or to work continuously
- Includes Hot-Link® System Cartridge Circulator, a Hot-Link bypass valve and flex hoses
- 3 Year Warranty

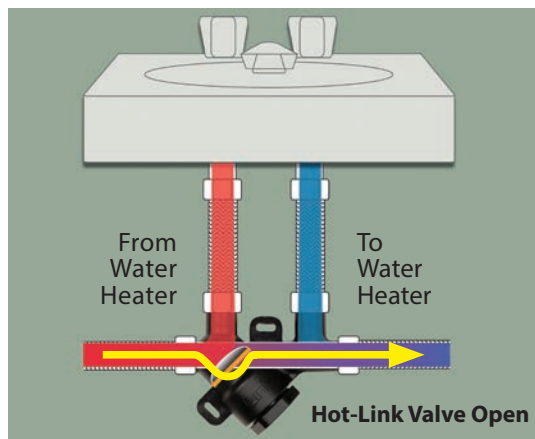
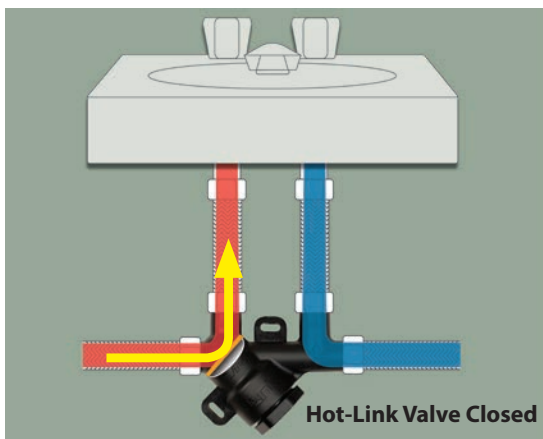

LEFT: No under-sink electricity needed. The Hot-Link Pump is mounted at the water heater.

Typical Hot-Link® Schematic

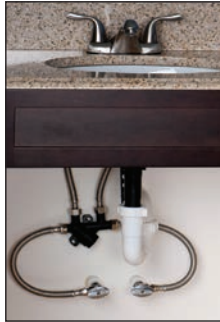

Installation is a snap. Uses existing plumbing.

Save Energy, Water and Time! Link up to instant hot water comfort!

Hot water without the waste!

The Taco Hot-Link® System for domestic hot water recirculation reduces the time it takes for hot water comfort to reach showers and faucets by recirculating “cooled” water back to the water heater; hot water lines remain hot. **The Hot-Link® System can save an average family up to 12,000 gallons per year** — water that normally goes down the drain while waiting for hot water.

How the Hot-Link System works.

A quiet and efficient Hot-Link circulator is installed at the water heater and a Hot-Link bypass valve is easily installed at the faucet furthest away from the hot water heater. The thermal disk technology tells the Hot-Link bypass valve what to do. No under sink electricity is needed.

Hot-Link System is easy to install.

The Hot-Link System circulator is installed at the water heater. Simply plug the 6' power cord into any standard

120V electrical outlet; no electrician required. Everything needed to install and operate the Hot-Link System is included in the box. Simply set the Hot-Link circulator timer to work during peak hours or to work continuously.

Benefits of the Hot-Link System.

Saves energy, water and time while providing instant hot water comfort. What's more, it's made by Taco, known by plumbing professionals as a world leader in high quality hydronic components since 1920.

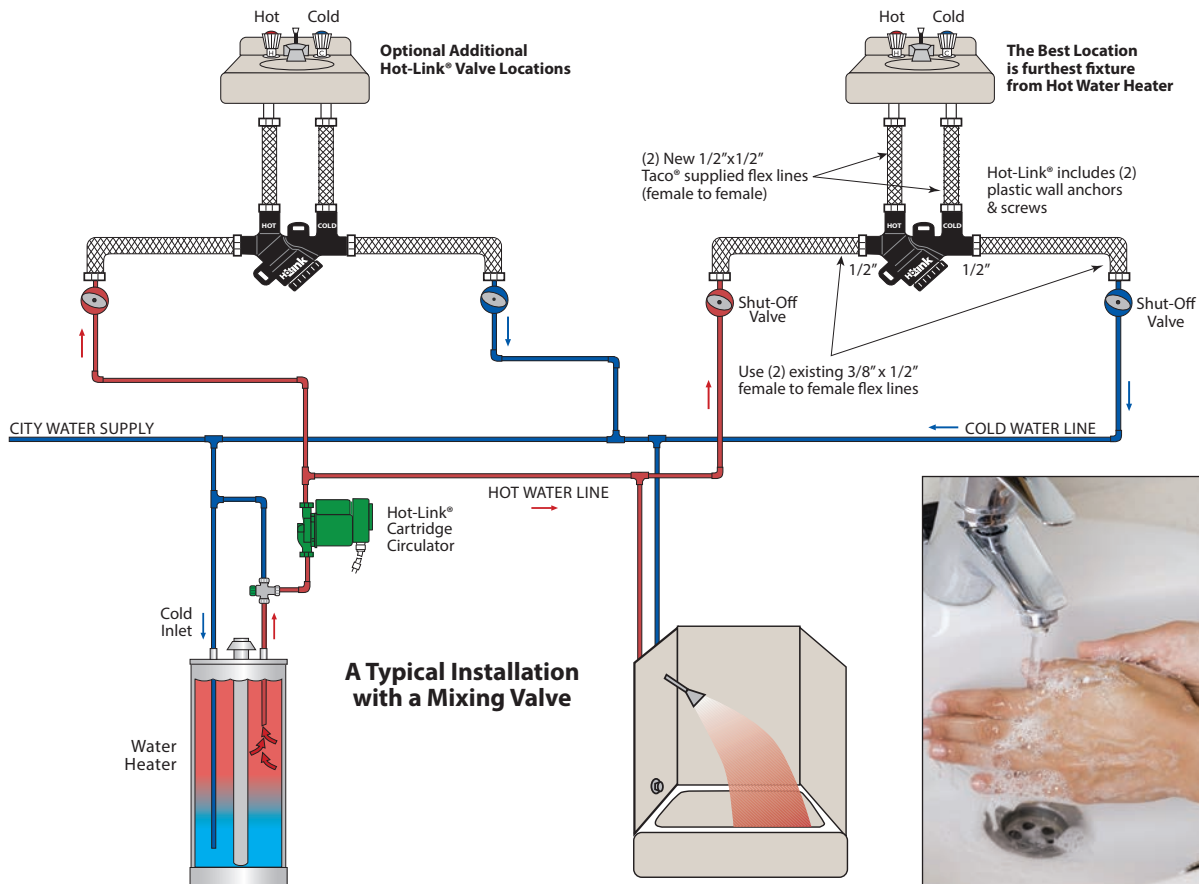

Submittal Data Information

Hot-Link® System (For Domestic Hot Water Recirculation)

Submittal Data # 101-148
Supersedes: New

Effective: 07/17/14

HLS-1 Includes:

- Hot-Link Valve
- Hot-Link Circulator
- (2) Braided Flex Hoses
- 3/4" Bronze Union

Materials of Construction — Pump & Union

- Casting (Volute).....Stainless Steel
- Stator Housing.....Steel
- Cartridge.....Stainless Steel
- Impeller.....Noryl
- Shaft.....Ceramic
- Bearings.....Carbon
- O-Ring.....EPDM
- Union.....Bronze

Materials of Construction — Hot-Link Valve

- Body.....Nylon
- Thermal Disk Actuator.....Bi-Metal
- O-Ring Seals.....EPDM
- Integral Flow Check (IFC®):
 - Body, Plunger.....Acetal
 - O-Rings.....EPDM
- Screen.....304 SS
- Stem.....Nylon
- Actuator Cartridge.....Stainless Steel
- Braided Flex Hoses.....Stainless Steel

Certifications & Listings



Dimensions & Weights: Hot-Link Valve

Connection	A		B		C		D		Ship Wt.	
	in.	mm	in.	mm	in.	mm	in.	mm	Lbs.	Kg
1/2" MNPT	4	102	4-7/16	87	1-3/4	41	2-1/2	64	0.37	0.17

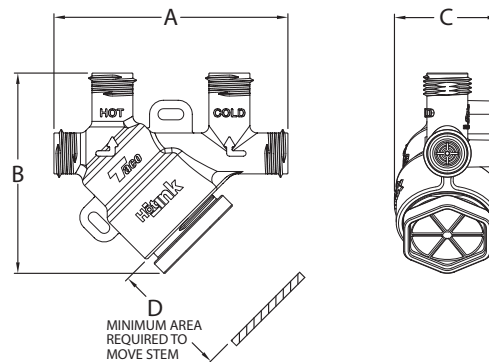

Hot-Link Circulator

A		B		C		D		E		F		Ship Wt.	
in.	mm	in.	mm	in.	mm	in.	mm	in.	mm	in.	mm	Lbs.	Kg
7-1/4	184	1-15/16	49	2	51	3-1/16	78	5-1/4	134	3-5/16	84	7.0	3.2

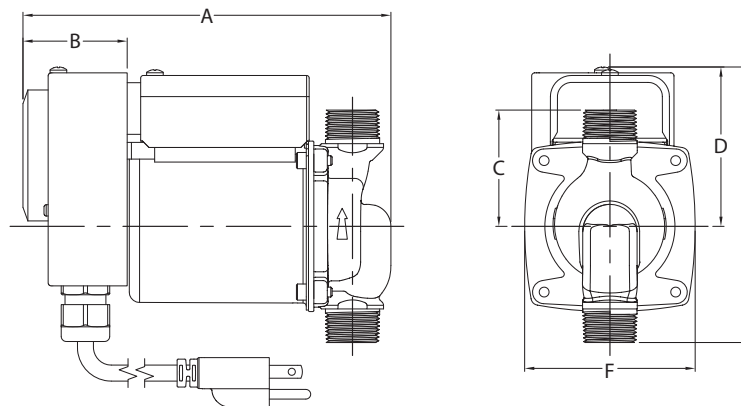

Electrical Data

Model	Volts	Hz	Ph	Amps	RPM	HP
Hot-Link Circulator	115	60	1	.52	3250	1/40
Motor Type	Permanent Split Capacitor Impedance Protected					

